

Proto-Shield Kit

1 DESCRIPTION

The PTSolns *Proto-Shield Kit* is a shield designed to enable the user to prototype their circuit as a shield. A unique prototyping section allows for much flexibility. Two configurable central power rails run across the entire length of the board. Above and below these rails are rows-of-four sections, mimicking the traditional breadboard layout. The board is fully stackable with all the microcontroller's pins from below having a breakout.

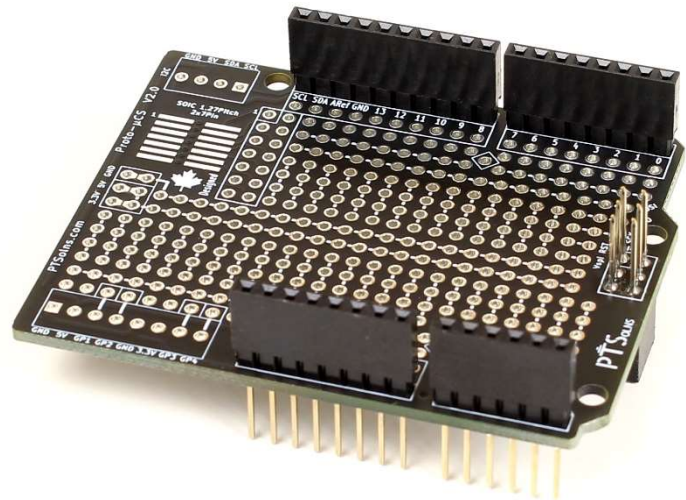

An I2C interface makes it easy to connect any peripheral via the I2C bus. The 8-pin general purpose breakout let's the user add any other signal as required. The onboard SOIC interface allows for a DIP SMD IC of up to 14 pins to be integrated into the *Proto-Shield*.

The *Proto-Shield* is packed with features unlike any other board of its kind. This document outlines these features, technical specifications, and demonstrates just two of near unlimited application examples.

Table of Contents

1 DESCRIPTION.....	1
2 DOCUMENT REVISION HISTORY.....	3
3 PRODUCT FEATURES.....	4
3.1 Compatibility.....	4
3.2 Prototyping Section Layout.....	5
3.3 Stackability & Pin Breakout.....	7
3.4 I2C Breakout.....	8
3.5 General Purpose Breakout.....	9
3.6 Diamond Tunnel.....	10
3.7 SOIC Interface.....	11
3.8 Mounting Holes.....	12
3.9 Mark of Authenticity.....	13

- 4 PHYSICAL PROPERTIES.....14
- 5 ELECTRICAL PROPERTIES16
- 6 EXAMPLE APPLICATION.....17
 - 6.1 Custom Sensor Shield17
 - 6.2 LCD Shield18
- 7 KIT PACKAGE CONTENTS.....19

2 DOCUMENT REVISION HISTORY

Current document revision is Rev 0.

3 PRODUCT FEATURES

This section highlights the features of the *Proto-Shield*. Some of the features are graphically shown in Figure 1. More detail is provided in the corresponding sub-sections.

The *Proto-Shield Kit* is not fully assembled, and soldering of the stacking headers is required.

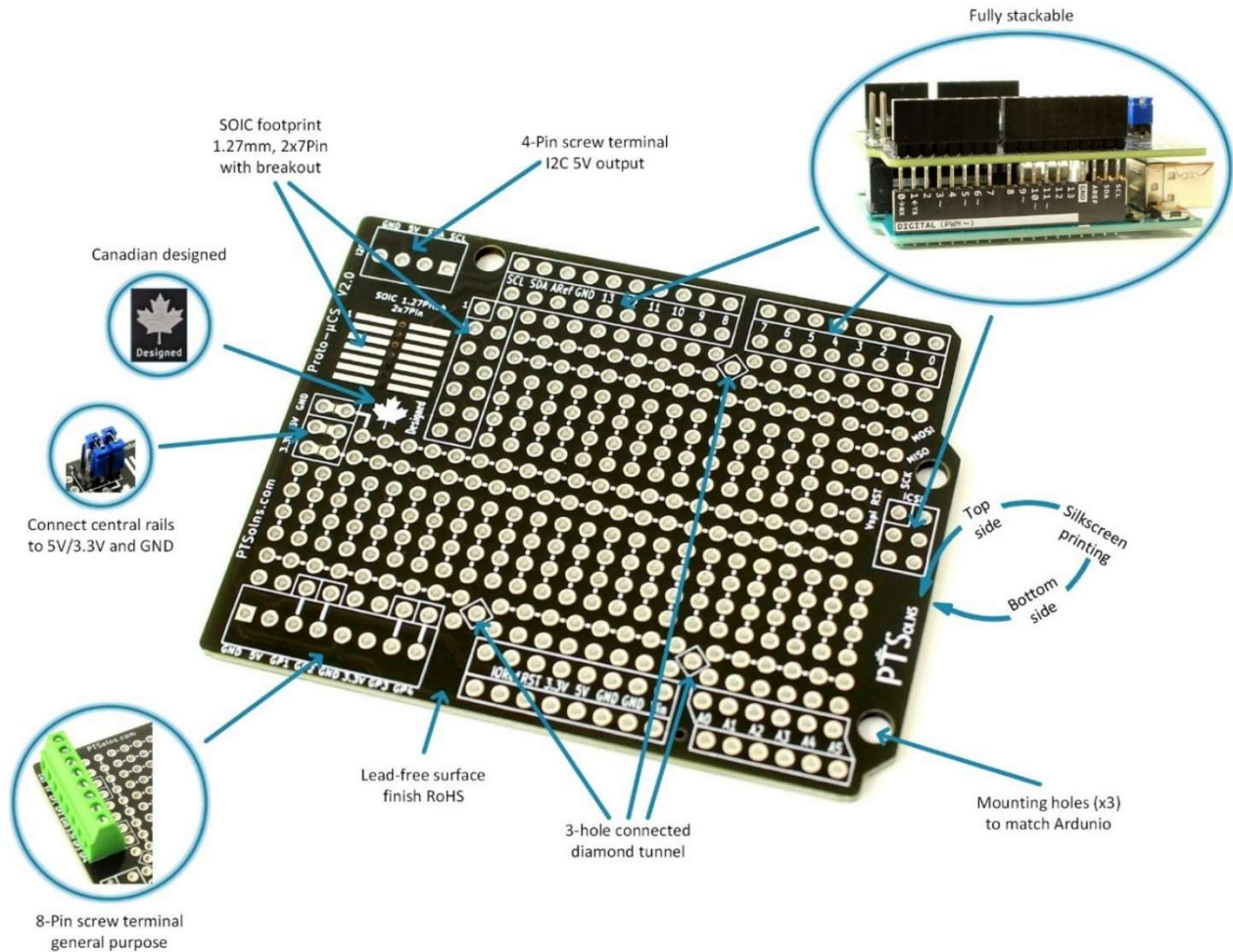

Figure 1: Features of the *Proto-Shield*.

3.1 Compatibility

The physical PCB outline is the same as the Arduino Uno R3 or Leonardo. Three of the four mounting holes on the Uno R3/Leonardo are found on the *Proto-Shield*, with the same position and diameter. The fourth mounting hole was sacrificed to add an interface (see sub-section 3.5). The board has full stacking capability. All of the pins of the Uno R3/Leonardo have a breakout on the shield. The *Proto-Shield* is compatible with the Arduino Uno R3, Mega 2560 R3, Leonardo and Due, and any other similar microcontroller. Note that not all microcontrollers operate at the same voltage. Therefore, when plugging the *Proto-Shield* into a microcontroller please note the operating and logic level voltage as this will be reflected on the shield. As an example, see sub-section 3.4 regarding an I2C interface.

3.2 Prototyping Section Layout

The *Proto-Shield* offers a unique prototyping layout with four different types of sections. Electrical connections within each section are indicated by white dashed silkscreen printed lines, as shown in Figure 2 by blue, red, green, and yellow outlines and are explained as follows. Figure 12 shows the electrical connections of the entire board, including the above-mentioned prototyping sections.

Blue outline in Figure 2

Two central power rails running left to right. By default, these rails are not connected. The upper rail can be connected to GND by bridging the top-left jumper pads. The lower central rail can be connected to either 5V or 3.3V by bridging the corresponding jumper pads similarly. Note that these jumper pads can be soldered permanently. Alternatively male header pins and 2-pin jumper caps can be used to make temporary connections.

Red outline in Figure 2

Above and below the two central power rails are through-holes sections organized in rows-of-four, resembling the pattern of a breadboard. The upper section contains 14 rows-of-four, while the lower section contains 24 rows-of-four. Together, these two sections can support prototyping with a DIP IC of up to 28 pins (2x14 pins) of both the narrow type as well as the wide type.

Green outline in Figure 2

A total of six rails of various lengths are found above and below the main prototyping sections, running parallel to the central power rails. These rails are intended to bring signals across the board horizontally.

Yellow outline in Figure 2

At the very top and bottom of the prototyping sections are electrically isolated through-holes. These holes have no connections and do not form a rail.

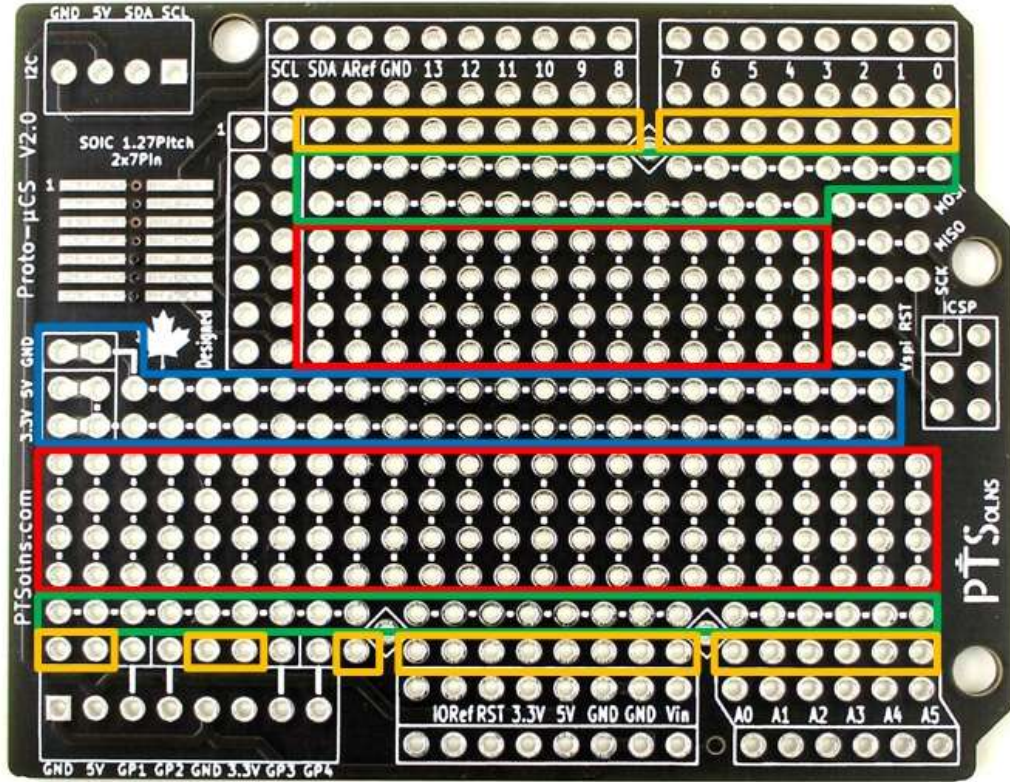

Figure 2: Prototyping section layout.

3.3 Stackability & Pin Breakout

The *Proto-Shield* is a fully stackable shield. The *Kit* comes with the required stacking female headers (see Section 7 for full contents list). An example image of the shield used in a stack can be seen in Figure 14. With this stacking feature, all the pins of the below microcontroller are available at the next upper stacking layer. Furthermore, all the pins of the below microcontroller are broken-out next to the stacking headers, as shown in Figure 4.

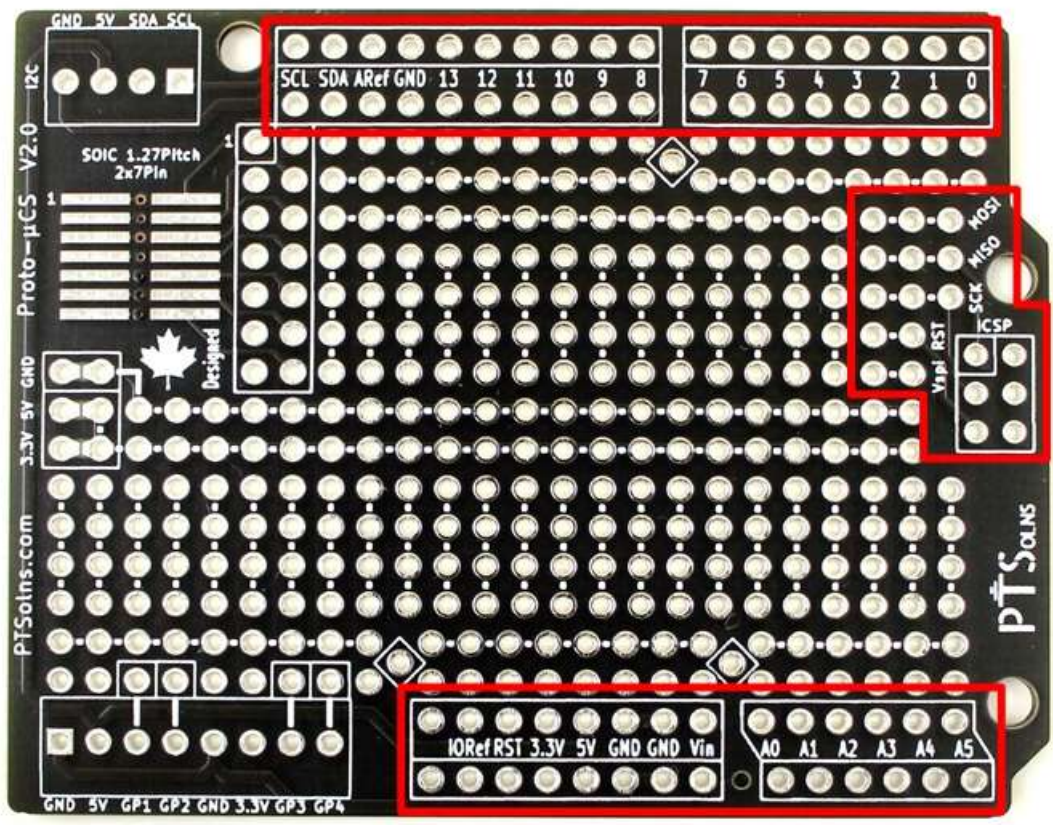

Figure 3: Stackability and pin breakout.

3.4 I2C Breakout

In the top-left corner of the *Proto-Shield* is an I2C breakout, providing the following pins: GND, 5V, SDA, SCL. As can be seen in Figure 4, the footprint is designed to accept a 4-pin 2.54mm screw terminal. However, a male or female header, or anything else similar, can be used in this footprint.

Note that the 5V voltage, as well as the SDA and SCL logic signals, are only at 5V if using a microcontroller that operates on 5V. For example, if using the Arduino Uno R3, Mega 2560 R3, or Leonardo. If, however, using a 3.3V microcontroller these I2C signals will correspondingly also be at 3.3V. For example, if using the Arduino Due. The user should take caution in noting the operating voltage of the microcontroller in use.

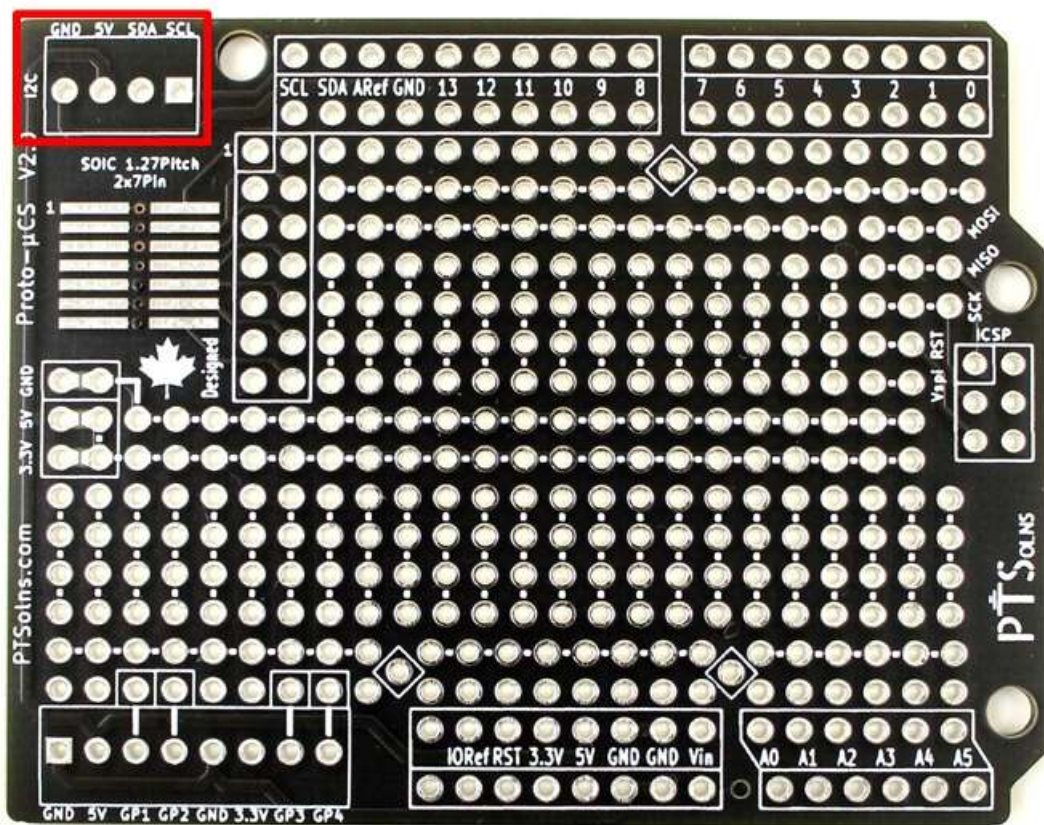

Figure 4: I2C breakout.

3.5 General Purpose Breakout

At the bottom-left corner of the *Proto-Shield* is a general purpose (GP) breakout, as seen in Figure 5. The GP breakout has the following pin arrangement (from left to right): GND, 5V, GP1, GP2, GND, 3.3V, GP3, GP4. Each of the four GP pins has a corresponding electrically connected adjacent pin, which can be used to connect the desired signal to. The footprint of the GP breakout is designed to accept an 8-pin 2.54mm screw terminal. However, a male or female header, or anything else similar, can be used in this footprint.

Note that the 5V voltage is only at 5V if using a microcontroller that operates on 5V. For example, if using the Arduino Uno R3, Mega 2560 R3, or Leonardo. If, however, using a 3.3V microcontroller this voltage pin will correspondingly also be at 3.3V. For example, if using the Arduino Due. The user should take caution in noting the operating voltage of the microcontroller in use.

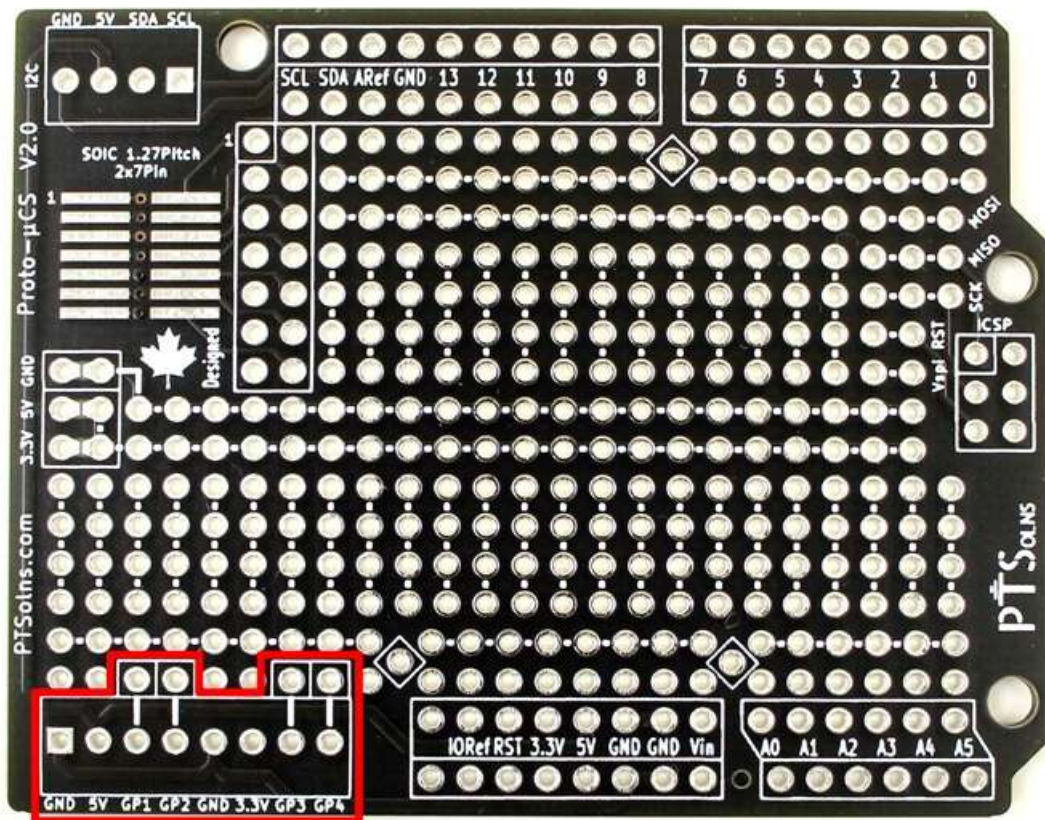

Figure 5: General purpose breakout.

3.6 Diamond Tunnel

Figure 6 shows three diamond-marked through-holes, collectively called a “diamond tunnel”. These three through-holes are electrically connected and can be used to bring one signal across the board for easy and convenient access.

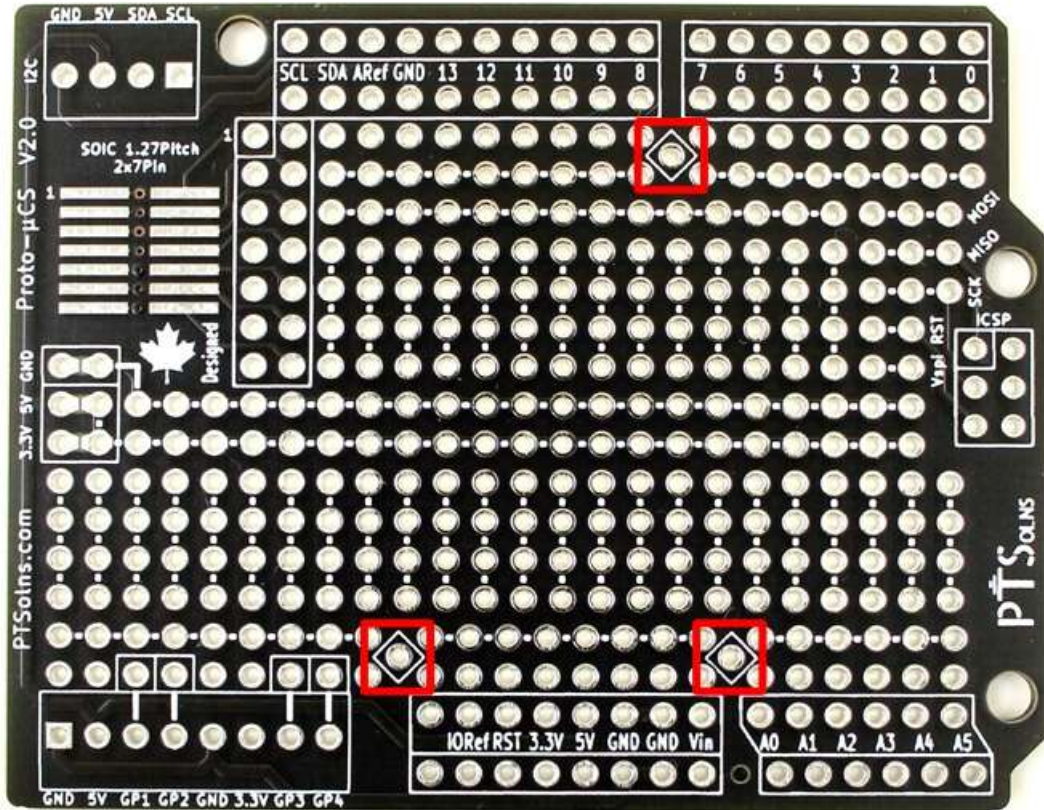

Figure 6: Diamond tunnel.

3.7 SOIC Interface

As shown in Figure 7, the *Proto-Shield* has a 1.27mm pitch, 2x7 pin SOIC interface, with corresponding breakout section. The breakout maps one-to-one the pins of the SOIC interface. The first pin is marked as “1” on both the SOIC interface and the breakout. All other pins follow the same pattern.

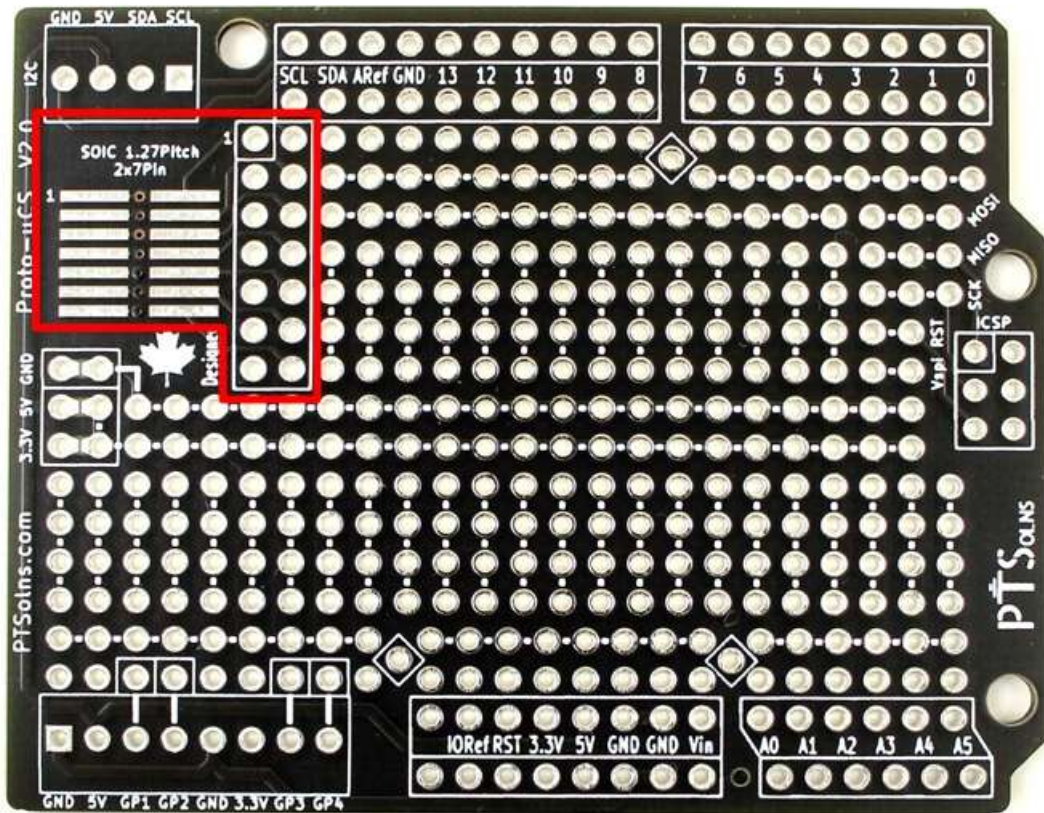

Figure 7: SOIC interface.

3.8 Mounting Holes

There are a total of three mounting holes on the *Proto-Shield*. These mounting holes match the position and diameter of the Arduino Uno R3. The fourth mounting hole near the bottom center of the Arduino Uno R3 is missing on the *Proto-Shield*. This was done in order to accommodate the general-purpose breakout (see sub-section 3.5).

For dimensions and arrangement of the mounting holes see Figure 11.

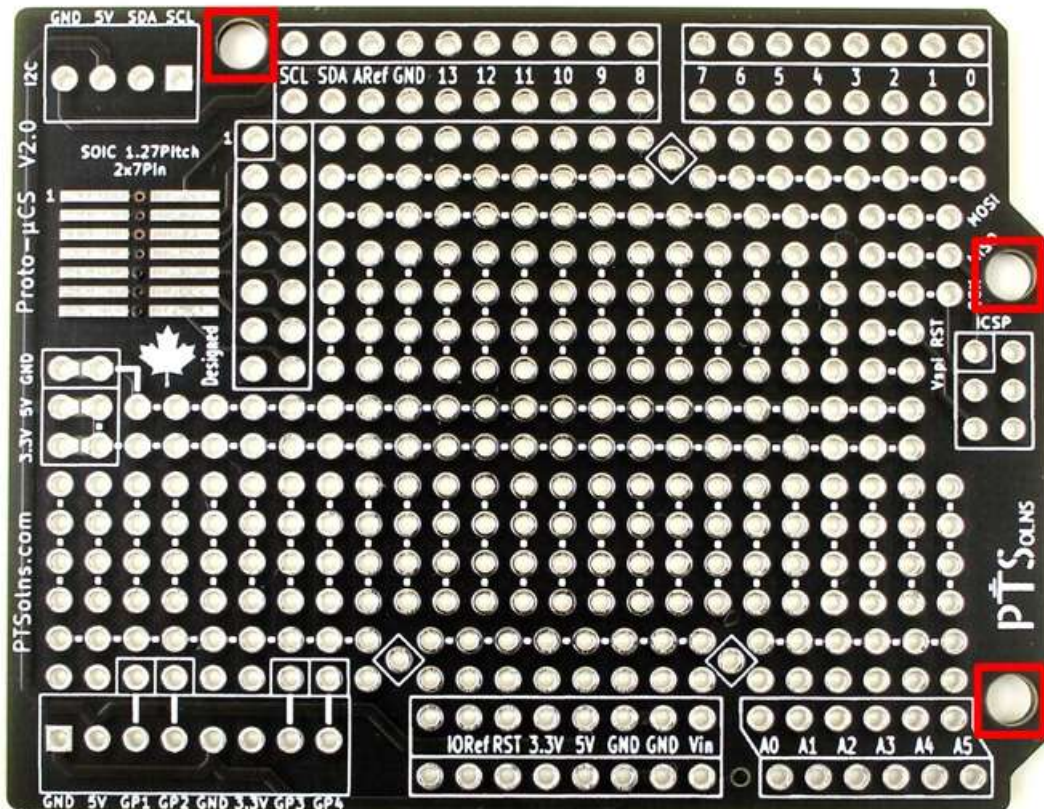

Figure 8: Mounting holes.

3.9 Mark of Authenticity

Authentic PTSolns PCBs have a black solder mask color and are marked with the “PTSolns” logo in white silkscreen printing. The “Canadian Designed” symbol, consisting of the Canadian Maple Leaf with the word “Designed” underneath, can also be found on the PCB in white silkscreen printing. The “PTSolns” trademark and the “Canadian Designed” symbols are shown in Figure 9.

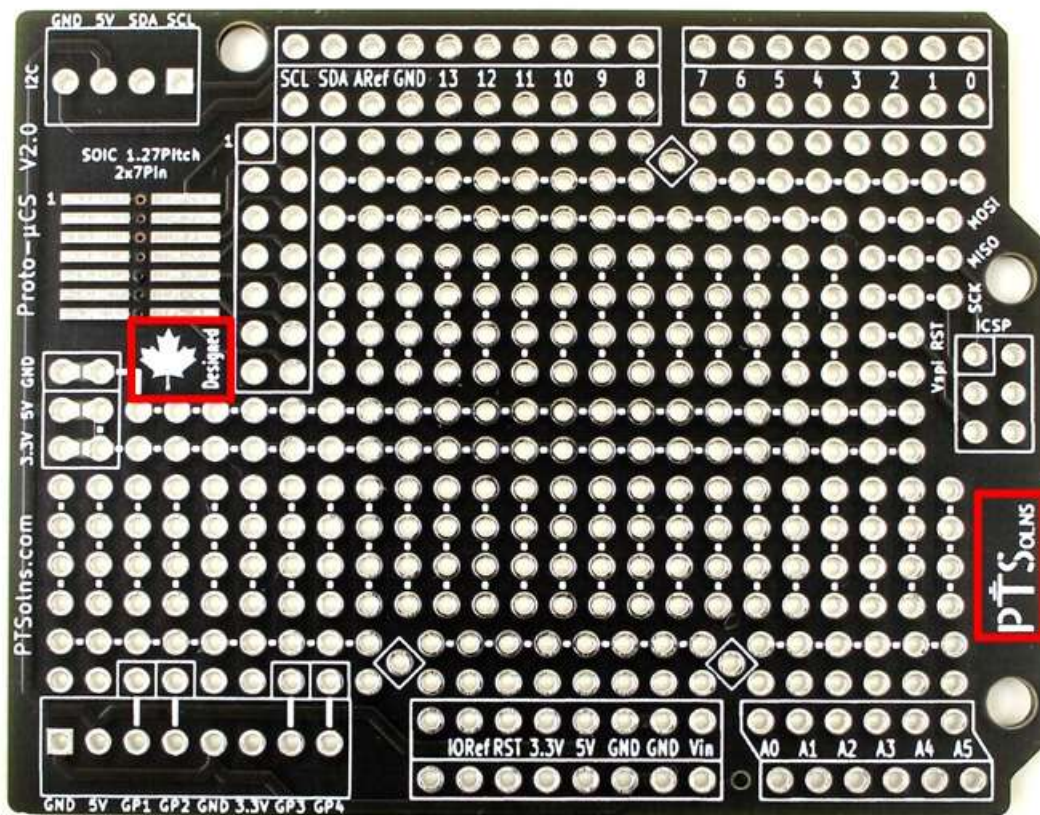

Figure 9: The "Canadian Designed" symbol found on authentic PTSolns PCBs.

4 PHYSICAL PROPERTIES

The physical properties of the *Proto-Shield* (PCB only) are outlined in Table 1.

Table 1: Physical Properties.

	Quantity	Value	Reference
PCB	Length (longest)	68.6 mm	Figure 11
	Width (longest)	53.3 mm	Figure 11
	Thickness	1.6 mm	Figure 11
	Weight	11 g	--
	Color	Black	--
	Silkscreen	White	--
Tie-point	Number of tie-points in prototyping section	266	Figure 11
	Tie point spacing	2.54 mm/0.1 in	Figure 11
	Tie-point hole diameter	1.0 mm	Figure 10
	Tie-point copper pad diameter	1.7 mm	Figure 10
Mounting	Mounting hole diameter	3.2 mm	--
	Mounting hole layout	--	Figure 11
Material	Lead free HASL-RoHS surface finish		--
	FR-4 base		--

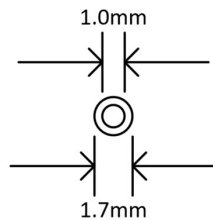

Figure 10: Dimensions of tie-point.

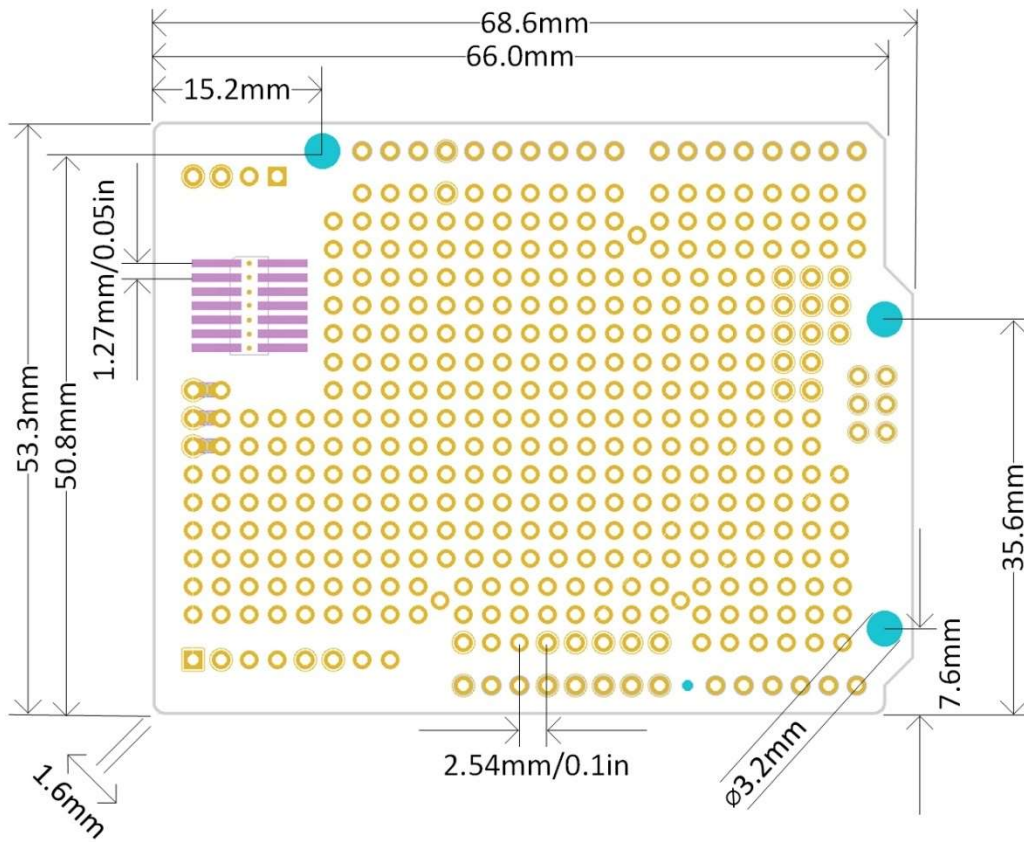

Figure 11: Dimensions of the Proto-Shield PCB.

5 ELECTRICAL PROPERTIES

In general, it is recommended to not exceed 0.5A of current on any trace of the *Proto-Shield*.

Electrical connections made by copper traces are shown in Figure 12. Copper traces have a weight of 1 oz/ft².

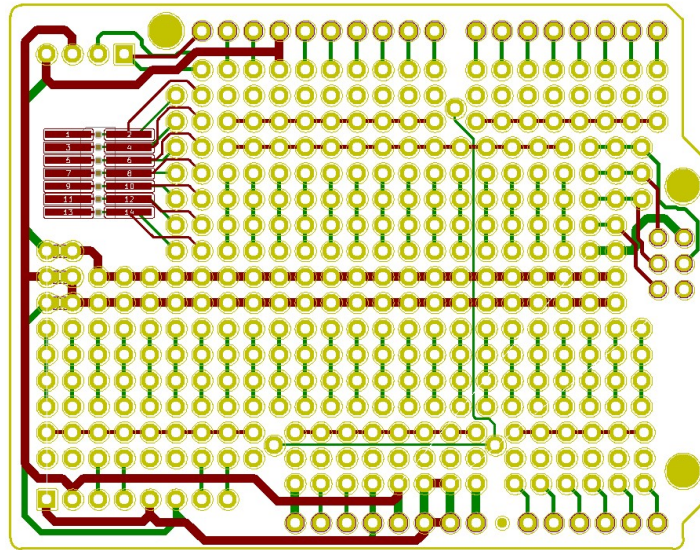

Figure 12: Electrical connections of the *Proto-Shield*.

6 EXAMPLE APPLICATION

The *Proto-Shield* is a general-purpose prototyping shield for Arduino Uno R3 and similar microcontrollers. As such, there are near unlimited applications and circuits a user can develop. This section demonstrates just two possible uses. Sub-section 6.1 shows a custom sensor shield, while sub-section 6.2 shows an LCD shield, which is used to print out the values of the sensor shield.

6.1 Custom Sensor Shield

This custom sensor shield includes two sensors: A) temperature/humidity sensor, and B) 3-axis accelerometer. These two sensors communicate with a microcontroller via the I2C bus. However, since these sensors work on 3.3V logic, meanwhile the microcontroller used operates on 5V, a 5V-to-3.3V logic level shifter (LLS) is added in order to interface with the 5V I2C bus of the microcontroller. Both sensors and the LLS fit on the *Proto-Shield* as shown in Figure 13. Stacking headers are used as this custom shield is intended to be used within a larger project.

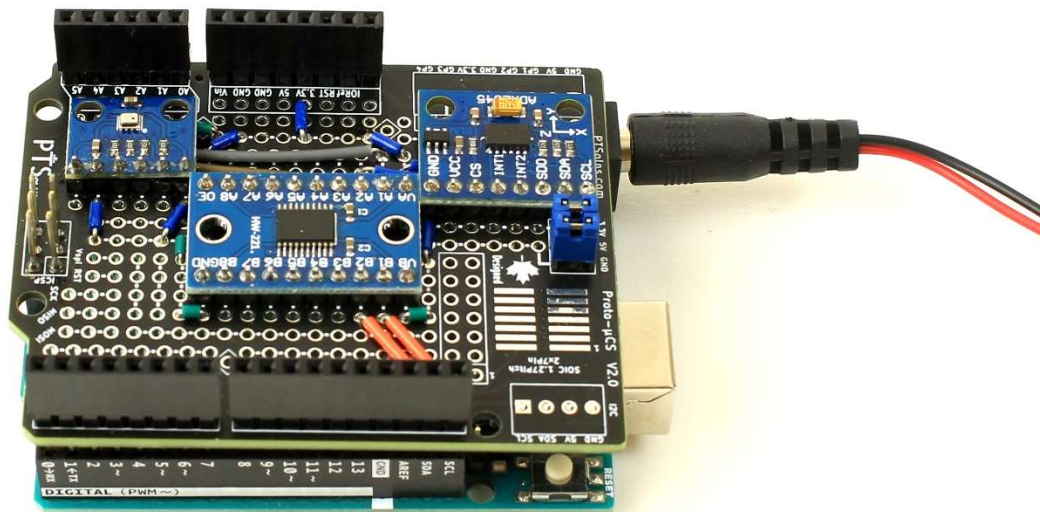

Figure 13: Custom sensor shield using the Proto-Shield.

6.2 LCD Shield

In order to view the data collected by the sensor shield a custom LCD shield is stacked on top, as shown in Figure 14. To make the LCD shield the PCF8574 IC was soldered to the *Proto-Shield*, which enables I2C communication between the LCD and the microcontroller. A 16-pin female header was used in order to connect the LCD pins to the PCB.

The first row of the display shows the temperature output, while the second row shows the x, y, z accelerometer reading. Note that stacking headers were not used for the LCD shield as it is intended to be on the top of the stack, and none of the pins below were needed to be made available.

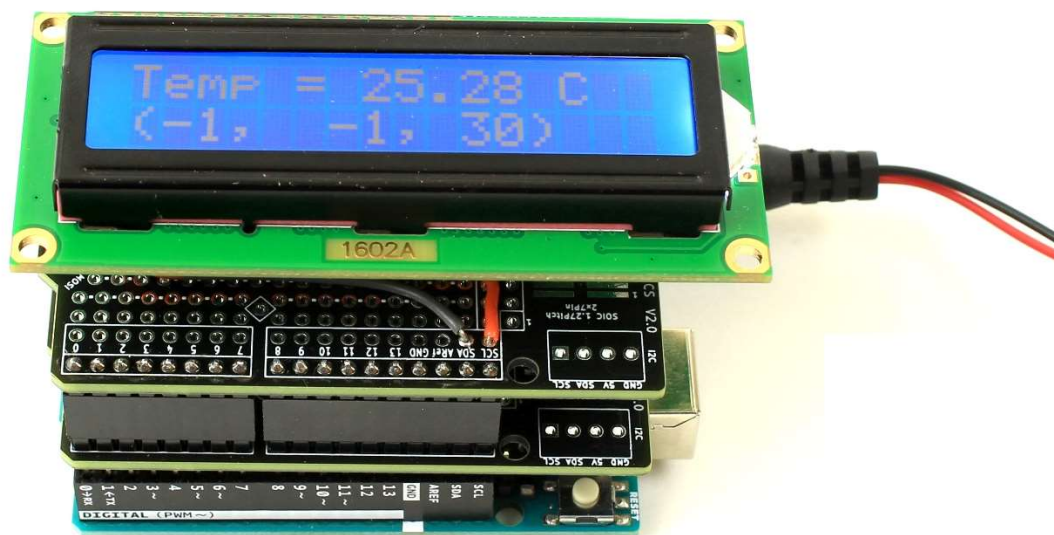

Figure 14: LCD shield using the Proto-Shield.

7 KIT PACKAGE CONTENTS

The following items are included in the *Proto-Shield Kit*. **This kit comes unassembled.**

This kit includes:

- 1pc PCB PTSolns *Proto-Shield*
- 1pc 1x6 pin stacking female header
- 2pcs 1x8 pin stacking female header
- 1pc 1x10 pin stacking female header
- 1pc 2x3 pin stacking female header